

Assemble parts in numerical order.

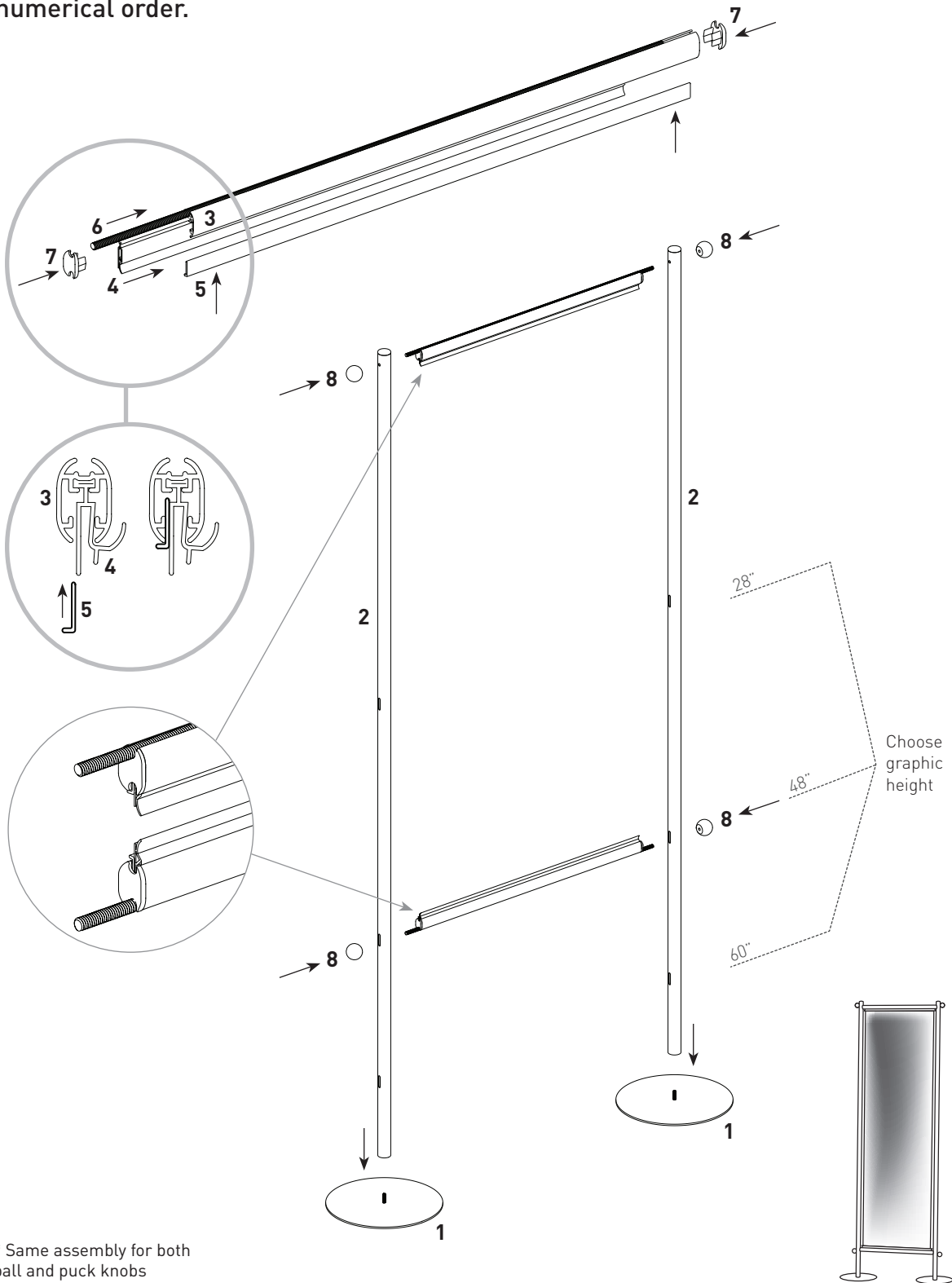
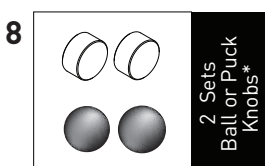
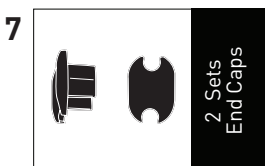
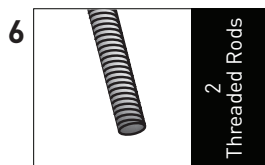
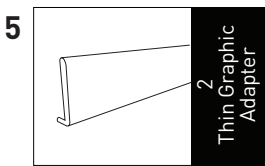
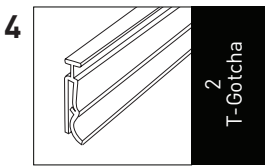
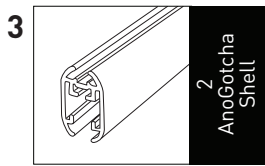
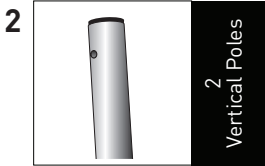
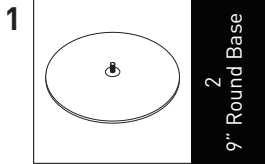

* Same assembly for both ball and puck knobs